

MSB

**GRASPING  
FORCEPS**



## Towel Clamps

Tuchklemmen  
Fissateli  
Pinzas de campo  
Pincés fixe-compresses

## Hemostats /Grasping Forceps

Hämostatika / Greifen  
Hémostats / Saisir  
Emostatici / Presa  
Krovoostanavlivayushchiye

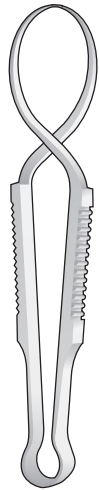

SCHAEDEL  
**BF-38**  
85 mm

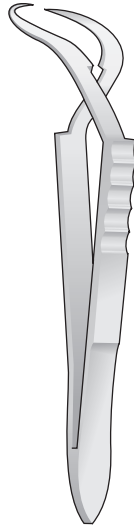

JONES  
**BF-48**  
90 mm

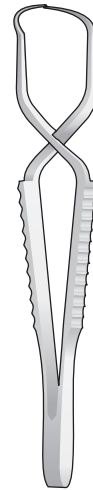

FAURE  
**BF-40**  
85 mm

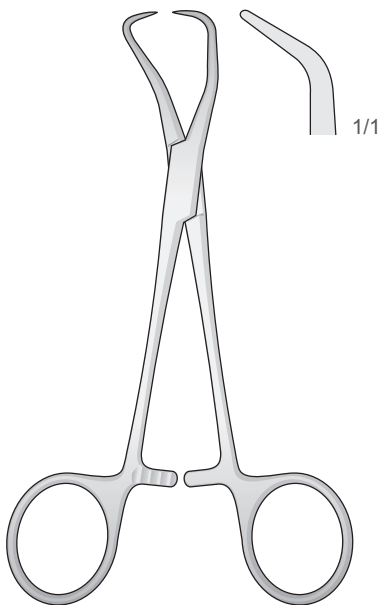

BACKHAUS  
**BF-42/BF-46**



**BF-42**  
90 mm



**BF-41**  
100 mm



**BF-44**  
110 mm

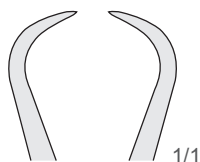

**BF-46**  
130 mm

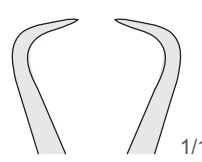

**BF-43**  
135 mm

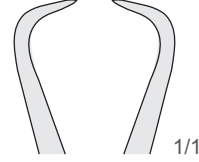

**BF-45**  
140 mm



## Towel Clamps

Tuchklemmen

Fissateli

Pinzas de campo

Pinces fixe-compresses

Für Papiertücher  
For paper cloths  
Per teli di carta  
Para paños  
Pour papier

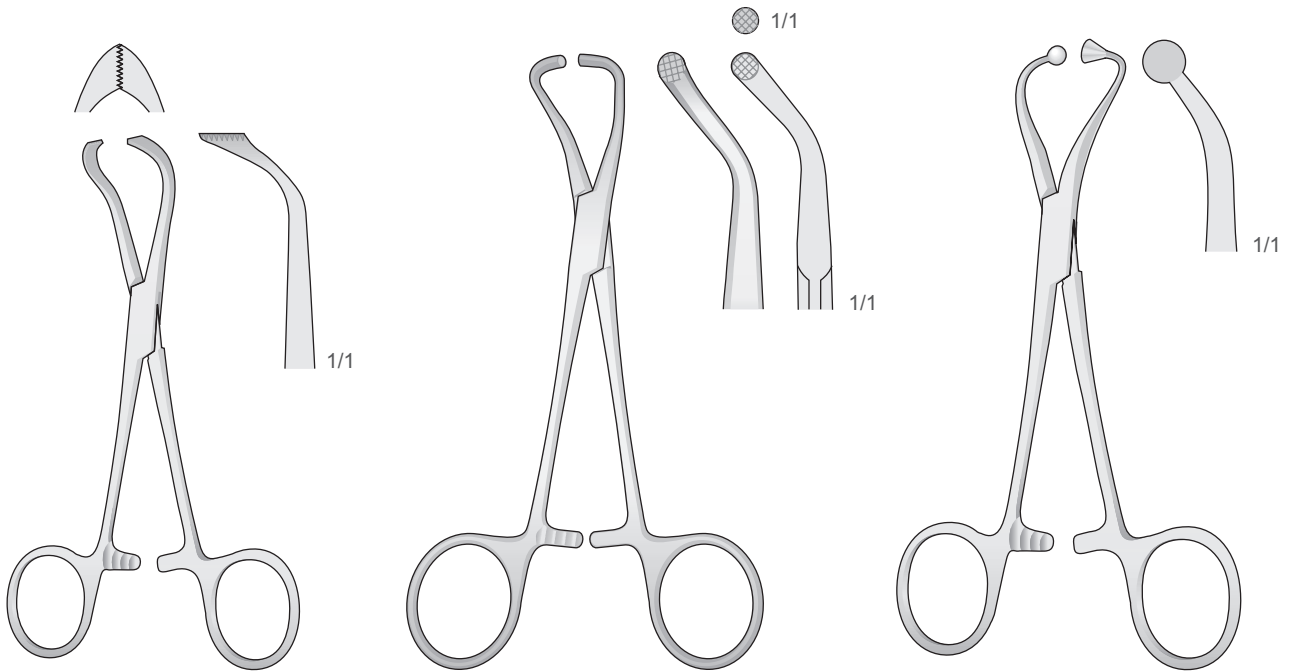

LORNA  
BF-50  
100 mm

BF-52  
130 mm

BF-75  
140 mm

## Sponge and Dressing Forceps

Schwamm und Tamponzangen  
 Pinze per tamponi e sponge  
 Pinzas para esponja y tampones  
 Pincas pour éponges et à pansement

## Hemostats /Grasping Forceps

Hämostatika / Greifen  
 Hémostats / Saisir  
 Emostatici / Presa  
 Krovoostanavlivayushchiye

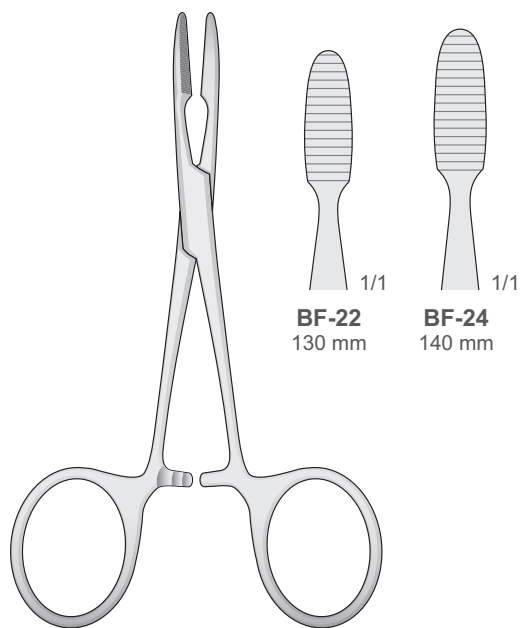

PEAN-MURPHY  
**BF-22/BF-24**

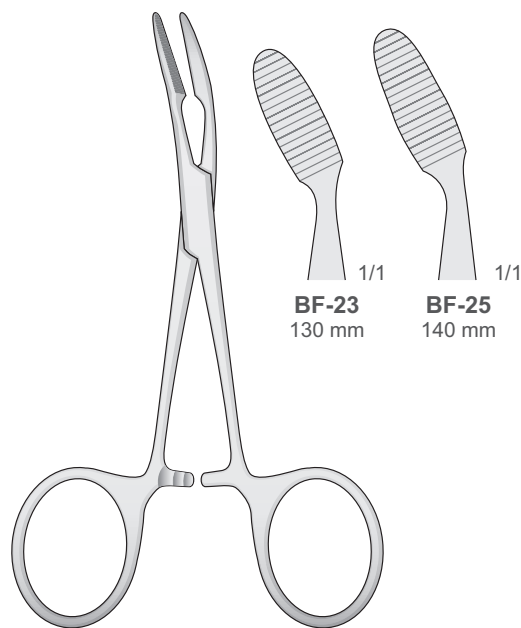

PEAN-MURPHY  
**BF-23/BF-25**

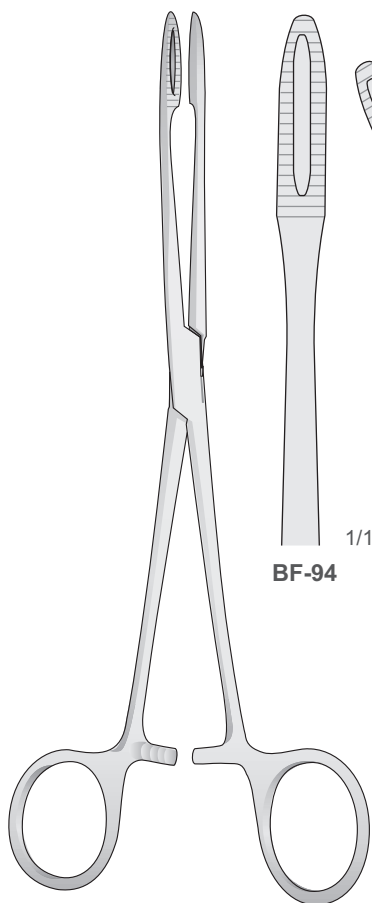

GROSS  
**BF-94/BF-95**  
 200 mm

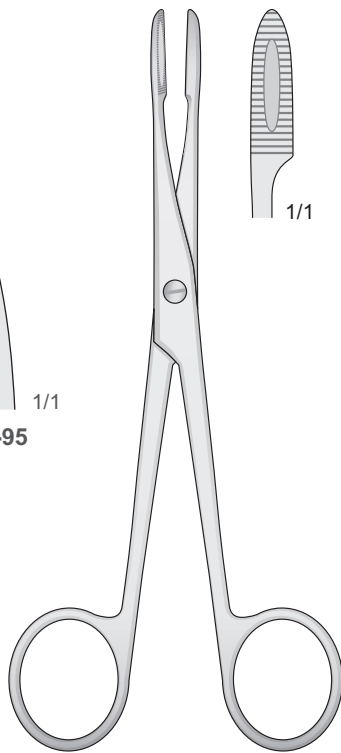

GROSS  
**BF-10** 130 mm  
**BF-12** 160 mm

Sinus klemmen  
 Sinus forceps  
 Pinze Sinus  
 Pinzas para seno  
 Pincas à Sinus

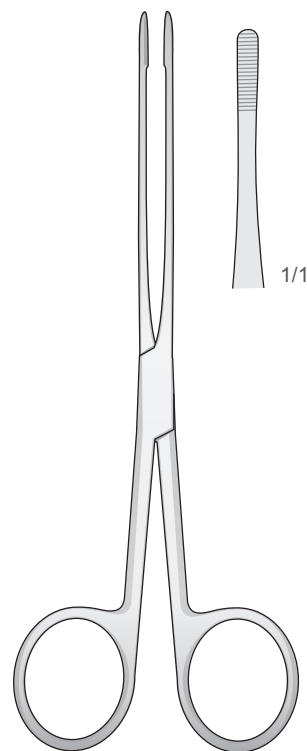

LISTER  
**BF-20**  
 150 mm



## Hemostatic Forceps

Arterienklemmen  
Pinze emostatiche  
Pinzas hemostáticas  
Pincas hémostatiques

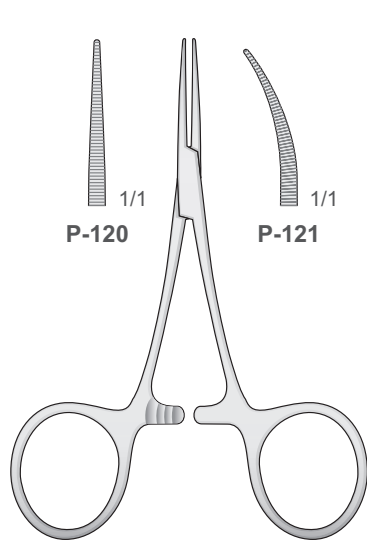

HARTMANN/BABY-MOSQUITO  
**P-120/P-121**  
95 mm

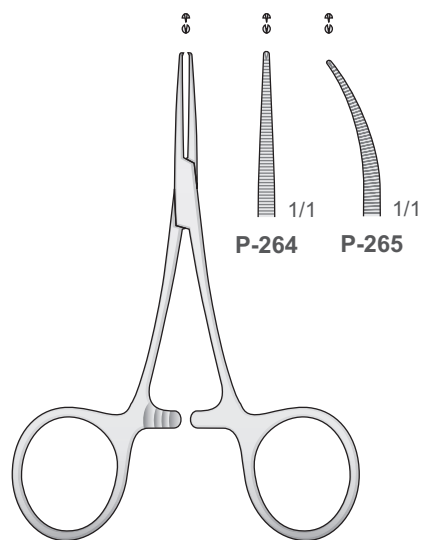

HARTMANN/BABY-MOSQUITO  
**P-264/P-265**  
95 mm

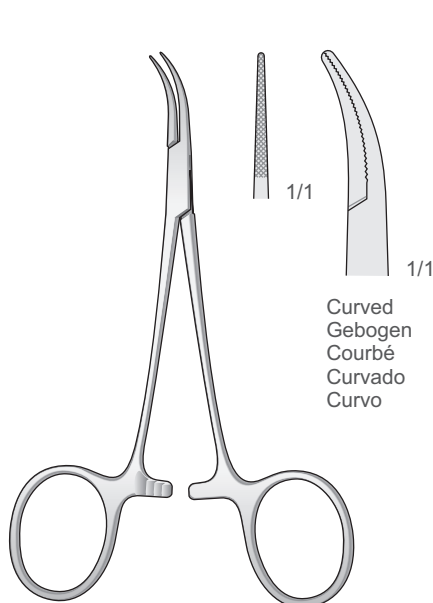

DANDY-MOSQUITO  
**P-332**  
120 mm

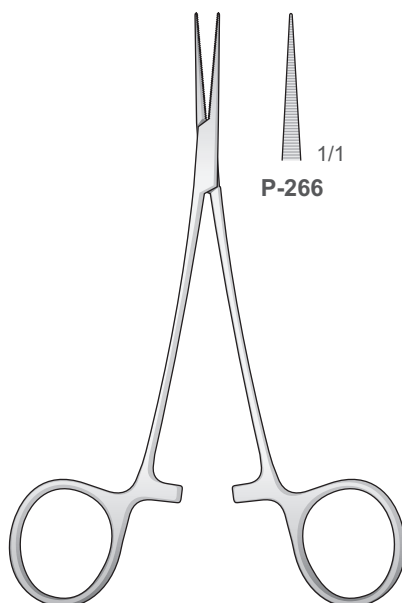

JACOBSON-MICRO  
**P-266**  
130 mm

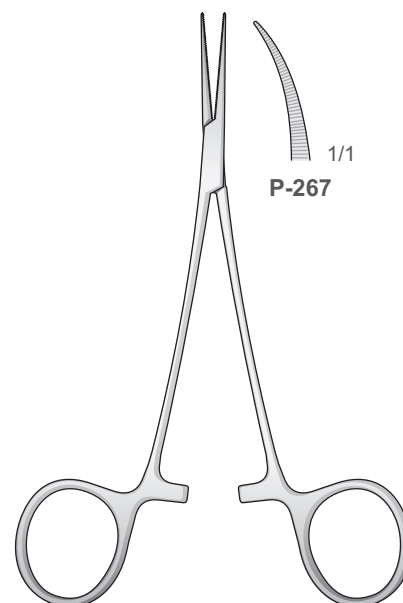

JACOBSON-MICRO  
**P-267**  
130 mm

Curved  
Gebogen  
Courbé  
Curvado  
Curvo

## Hemostatic Forceps

Arterienklemmen  
Pinze emostatiche  
Pinzas hemostáticas  
Pincas hémostatiques

## Hemostats /Grasping Forceps

Hämostatika / Greifen  
Hémostats / Saisir  
Emostatici / Presa  
Krovoostanavlivayushchiye

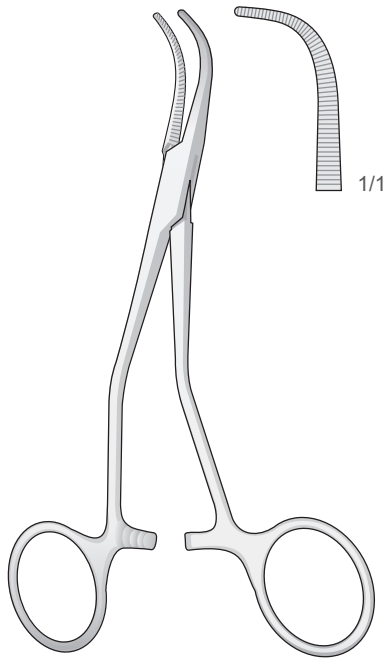

**P-15**  
130 mm

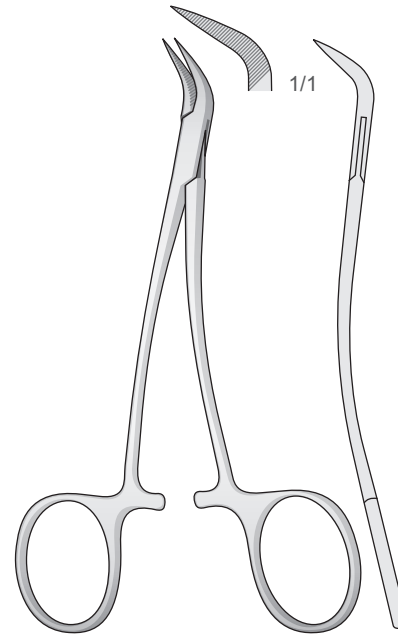

**PEET  
DR-40**  
120 mm

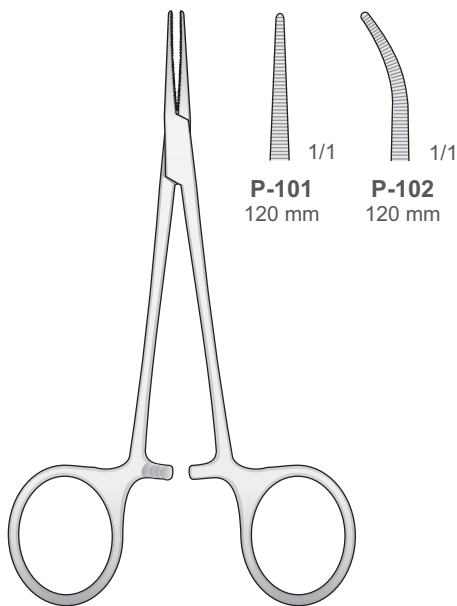

**MICRO-HALSTED  
P-101/P-102**

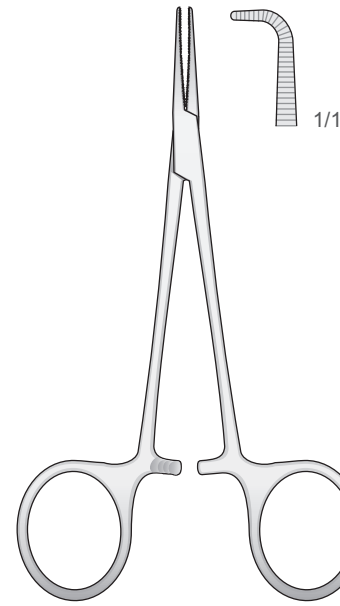

**MICRO-HALSTED  
P-135**  
115 mm

## Hemostatic Forceps

Arterienklemmen  
Pinze emostatiche  
Pinzas hemostáticas  
Pincas hémostatiques

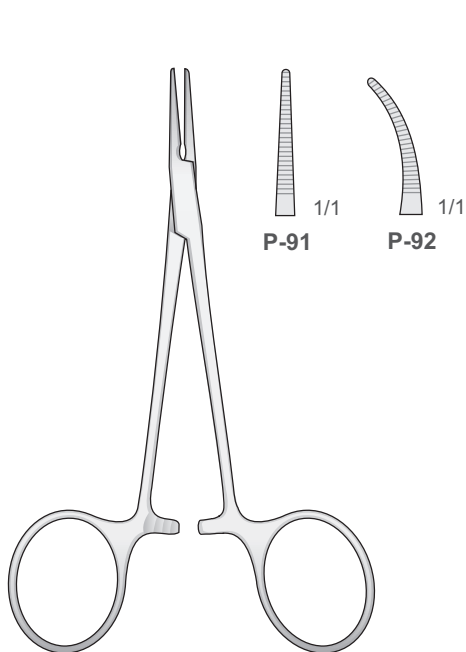

HALSTED  
**P-91/P-92**  
125 mm

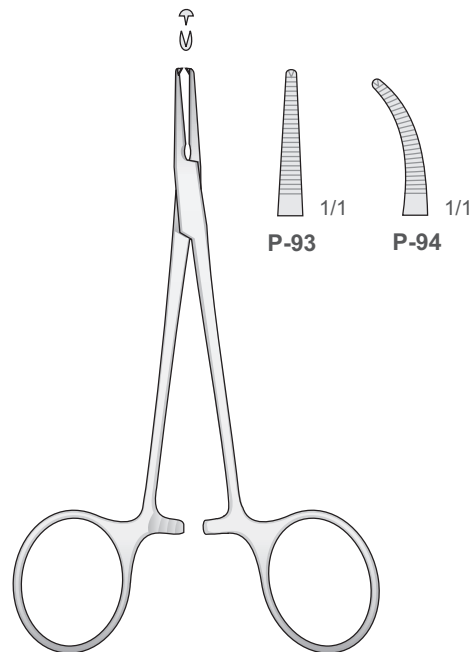

HALSTED  
**P-93/P-94**  
125 mm

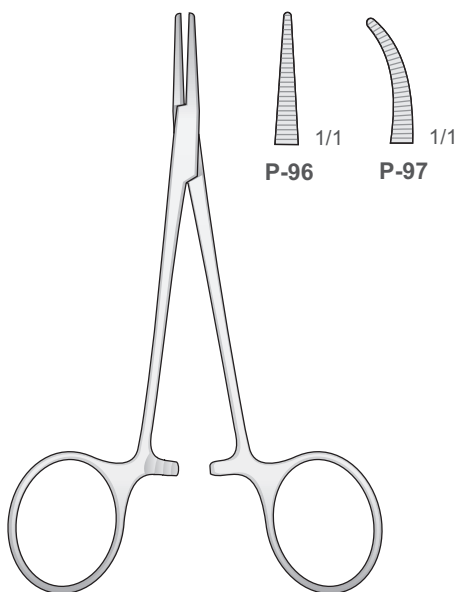

HALSTED-MOSQUITO  
**P-96/P-97**  
120 mm

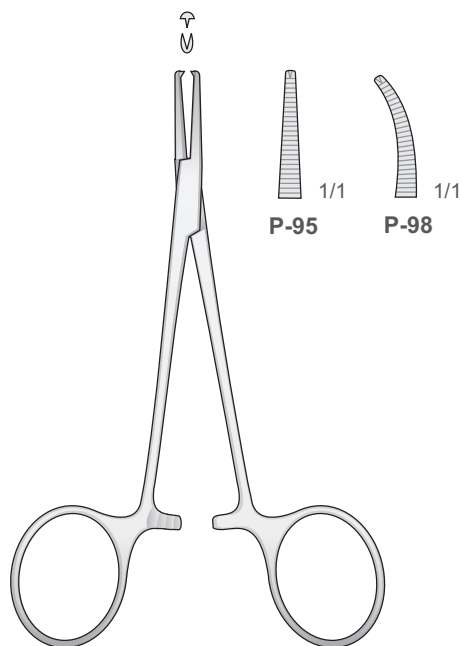

HALSTED-MOSQUITO  
**P-95/P-98**  
120 mm



## Hemostatic Forceps

Arterienklemmen  
Pinze emostatiche  
Pinzas hemostáticas  
Pincas hémostatiques

## Hemostats /Grasping Forceps

Hämostatika / Greifen  
Hémostats / Saisir  
Emostatici / Presa  
Krovoostanavlivayushchiye

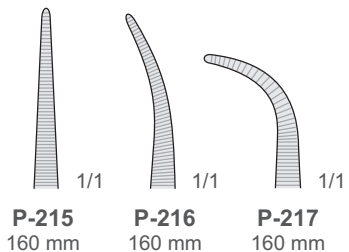
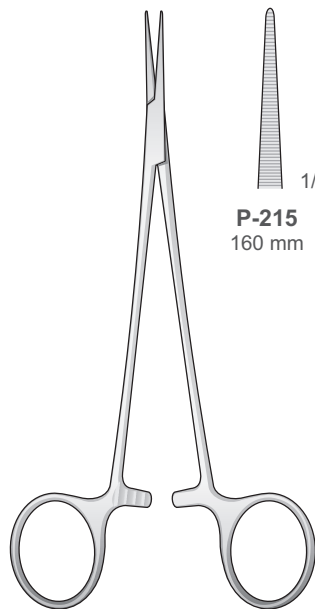

**P-215/P-217**  
160 mm

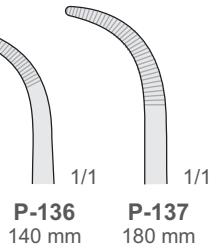
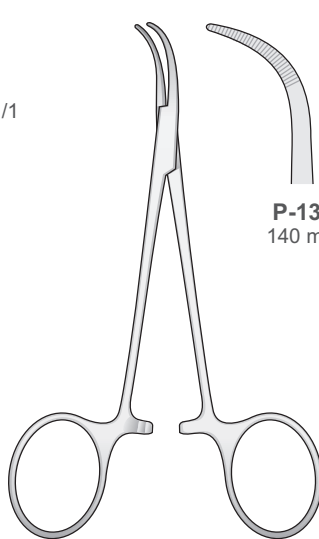

**BABY-MIXTER**  
**P-136/P-137**

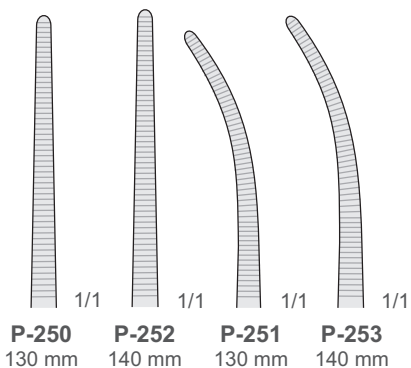
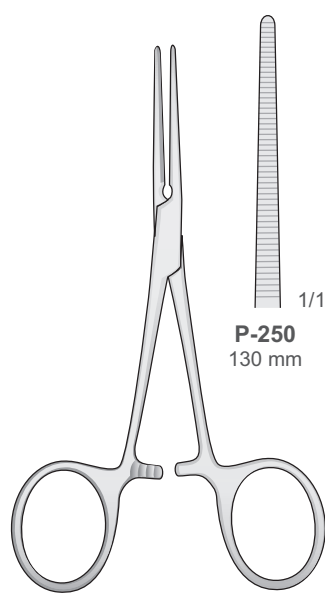

**PEAN**  
**P-250/P-253**

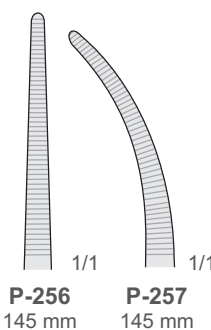
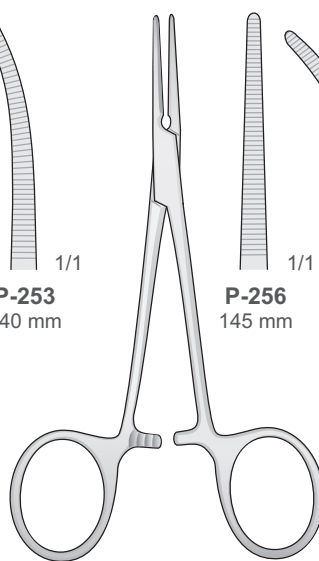

**PEAN**  
**P-256/P-257**

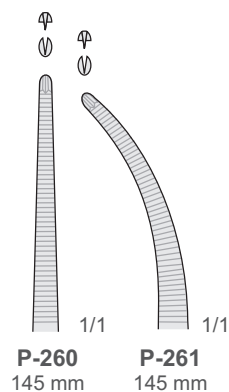
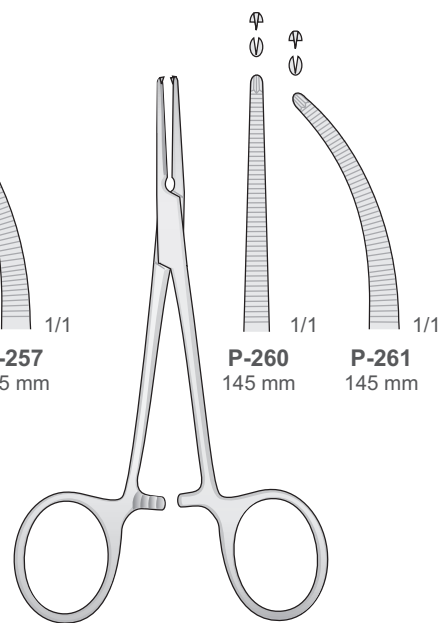

**KOCHER**  
**P-260/P-261**

## Hemostatic Forceps

Arterienklemmen  
Pinze emostatiche  
Pinzas hemostáticas  
Pincés hémostatiques

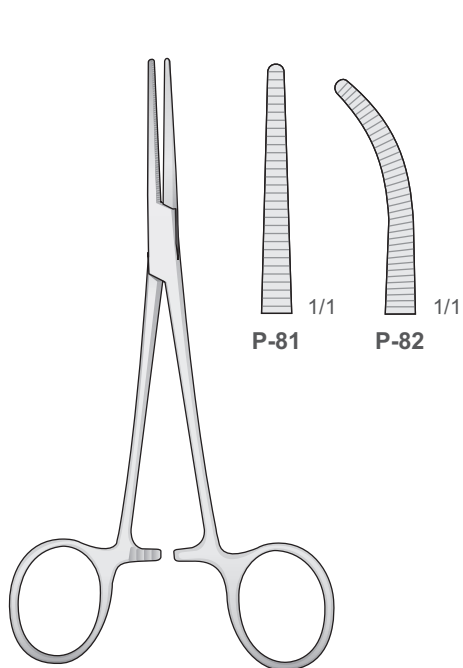

CRILE  
P-81/P-82  
140 mm

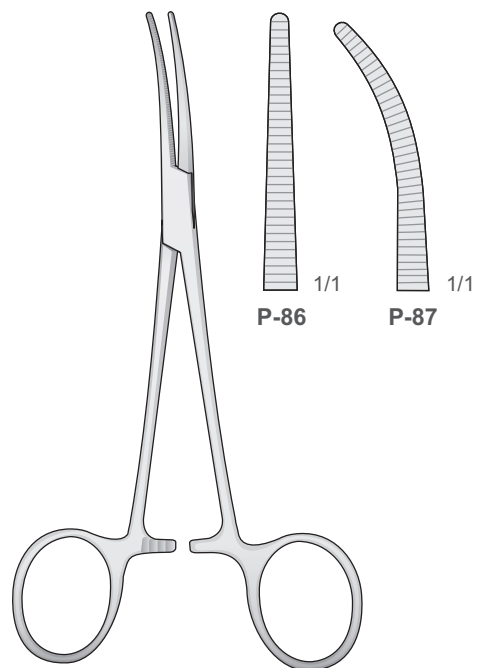

CRILE  
P-86/P-87  
160 mm

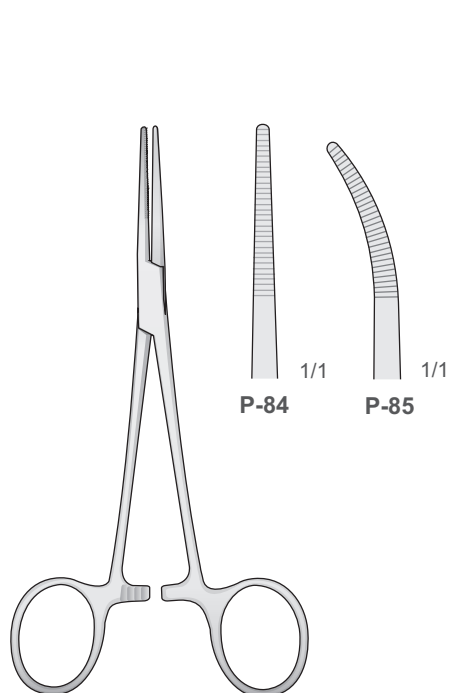

KELLY  
P-84/P-85  
140 mm

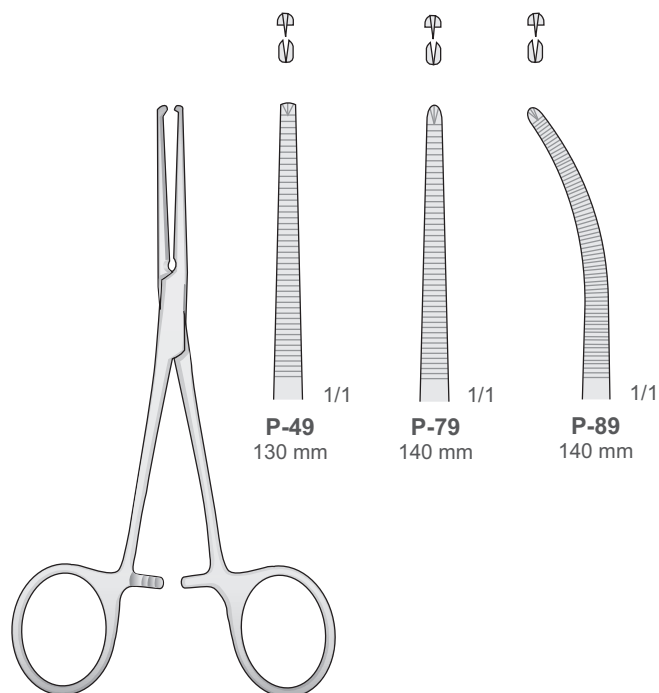

KOCHER  
P-49/P-89

## Hemostatic Forceps

Arterienklemmen  
Pinze emostatiche  
Pinzas hemostáticas  
Pincas hémostatiques

## Hemostats /Grasping Forceps

Hämostatika / Greifen  
Hémostats / Saisir  
Emostatici / Presa  
Krovoostanavlivayushchiye

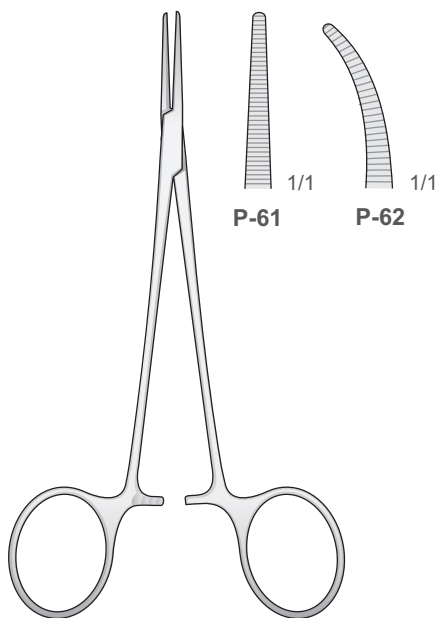

LERICHE  
P-61/P-62  
150 mm

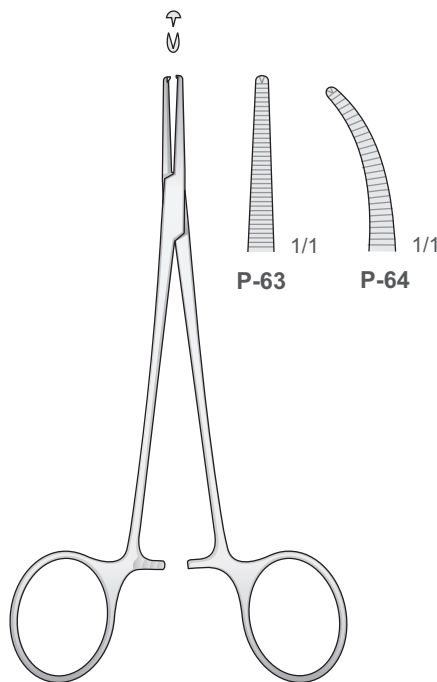

LERICHE  
P-63/P-64  
150 mm

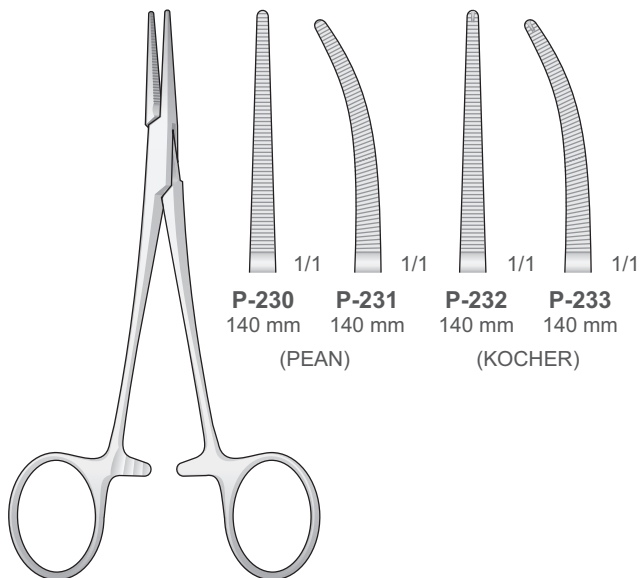

BABY-CRILE  
P-230/P-233  
140 mm

P-230 140 mm  
P-231 140 mm  
(PEAN)

P-232 140 mm  
P-233 140 mm  
(KOCHER)

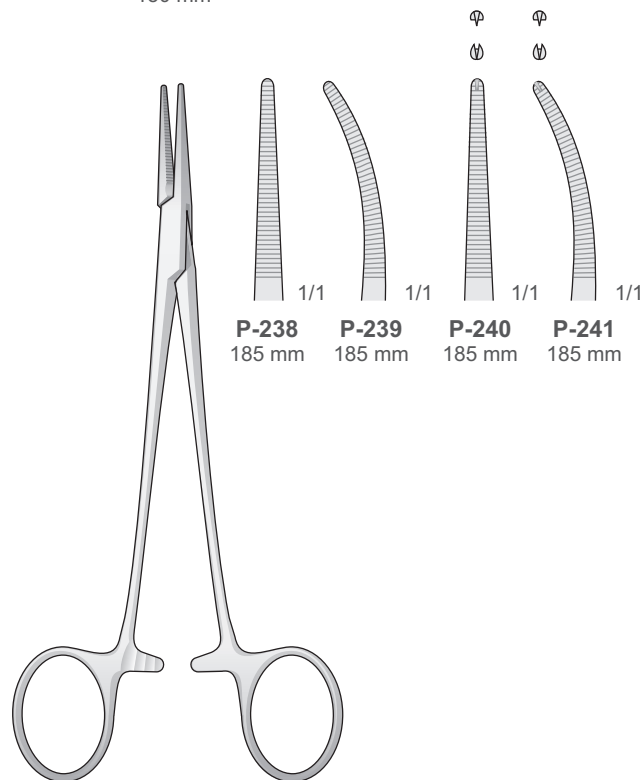

HALSTED  
P-238/P-241  
185 mm

P-238 185 mm  
P-239 185 mm  
P-240 185 mm  
P-241 185 mm



## Tissue Grasping Forceps

Gewebefasszangen  
Pinze per tessuti  
Pinzas para tejidos  
Pincas pour tissus

